





<b>F50</b>		x3
<b>E4</b>		x6
	6x8	
<b>K2</b>		x6
	7x70	
<b>L6</b>		x2

Nr	Ausmaß			St
1	1540	240	16	1
2	1534	220	15	1



1

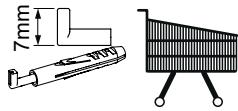
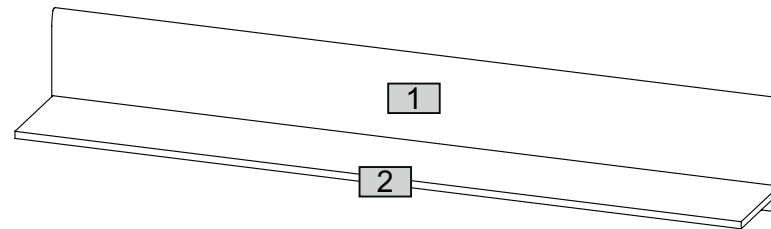
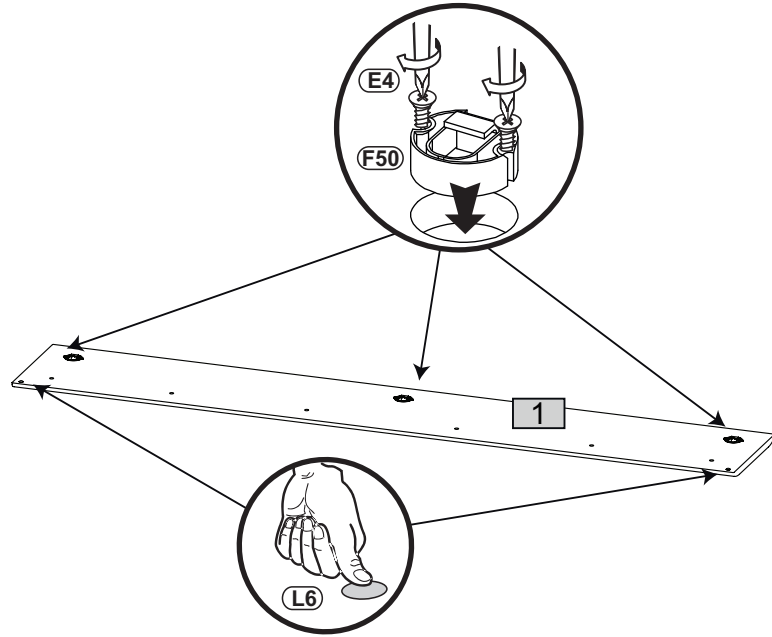
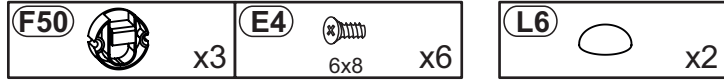

2

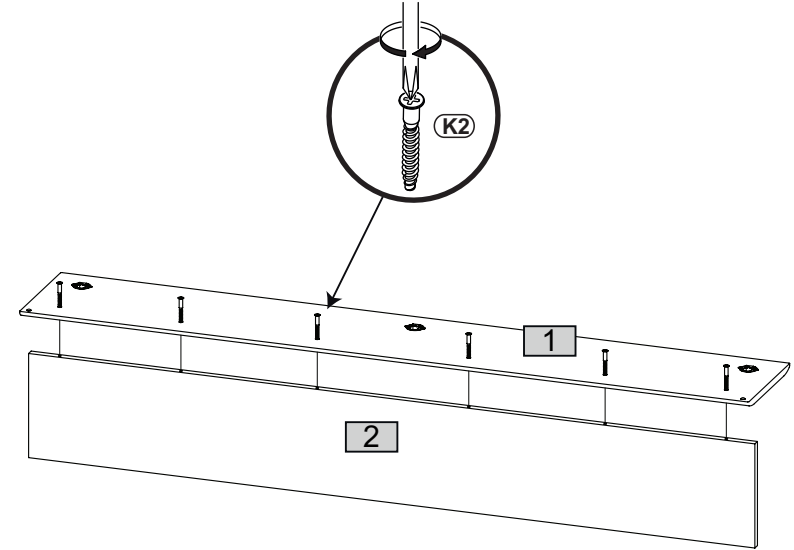
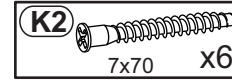

3

